



Laboratory 21

School Science Laboratories Design for the 21st century
Concepts and Proposals



Department of
Education

www.deni.gov.uk

AN ROINN

Oideachais

MÁNNYSTRÍE O

Lear



Foreword



This report funded by the Department of Education and commissioned by NEELB on behalf of the five Education and Library Boards sets out to take a fresh look at science laboratory design and suitability for learning and teaching in science for the 21st Century. The Pedagogical focus has shifted over the years from a predominantly didactic teaching mode to an emphasis on pupils' learning. This is further reinforced by the Revised Curriculum proposals which set skills and capabilities at the core of the learning process. Science laboratories have traditionally been designed as centres of investigation and this remains the case. Investigations now however can be conducted in part at the technological level eg. data logging processes as well as studies using a range of specialist equipment, materials and chemicals. To this end the science laboratory in schools must fulfil a range of functions from active experimentation and research to a fully integrated technological learning resource. The laboratory therefore is used to plan, carryout, report and evaluate experimental and investigative work.

The proposed layouts take into account the range of activities that occur in a typical science laboratory. Uppermost is the need for a safe working environment that separates the practical 'wet' area from the teaching and learning 'dry' area of the laboratory. It is the built-in flexibility of the design proposals that allow teachers to adjust the layout to fit the needs of the pupils in relation to the effective study of the subject. The proposals are innovative and exciting and will stimulate discussion on how laboratories in the 21st century may look. The proposals are a testament to the design skills and creativity of the team from the Interior, Industrial and Product Design course in the University of Ulster at Belfast, namely Dominic Logan and Gareth Ladley. They have set all of us involved in science education a challenge to debate how the design and layout of future science laboratories may impact on the uptake of science based subjects at all levels in post primary education and the enjoyment of working and learning in a stimulating and creative environment. The proposals set out in the report may form the basis of a flexible approach to specialist subject teaching in the post primary sector and aspects of the proposals may well be adaptable for a range of teaching situations. I hope you find the proposals thought provoking and provide the spark to reignite the debate on the structure and function of science based learning environments for the students of the future.

Sean Maguire

Sean Maguire
Adviser Science and Technology
North Eastern Education and Library Board

April 2006

Acknowledgements

The authors wish to acknowledge the support given by the Department of Education in funding the research and to Mr. David Beck, Science Inspector, for his invaluable help and advice during the course of the initial research and development work. Thanks are also due to the Department of Education Building Branch and to the Science Advisers of the Education and Library Boards for the very constructive feedback on the proposals.

Project Team

Dominic Logan

Design Consultant University of Ulster

Gareth Ladley

Design Consultant University of Ulster

Sean Maguire

Adviser Science and Technology
North Eastern Education and Library Board

David Beck

Education and Training Inspectorate
Department of Education

Willie McKeown

Assistant Adviser Technology and Design
North Eastern Education and Library Board

Contents



| | |
|---------------------------|----|
| Overview | 04 |
| Observations & Objectives | 06 |
| Forms of Teaching | 07 |
| User Needs | 08 |
| Inspiration | 09 |
| | |
| Laboratory 1 | 10 |
| Plan | 11 |
| Perimeter Benching | 12 |
| Formal Teaching | 13 |
| ICT Access | 14 |
| Group Discussion | 15 |
| Practical Mode | 15 |
| Role Play | 16 |
| Fume Cupboard | 17 |
| Disabled Access | 18 |
| | |
| Laboratory 2 | 19 |
| Plan | 20 |
| Flexibility | 21 |
| Formal Teaching | 22 |
| ICT Access | 23 |
| Group Discussion 1 | 24 |
| Group Discussion 2 | 25 |
| Role Play | 26 |
| | |
| Laboratory 3 | 27 |
| Plan | 28 |
| Ergonomics | 29 |
| Wet / Dry Areas | 30 |
| Formal Teaching | 31 |
| ICT Access | 33 |
| | |
| Laboratories Overview | 33 |
| Key Features | 34 |
| Teaching Wall | 35 |
| Display Boards | 36 |
| Colour | 37 |
| Appendices | 38 |

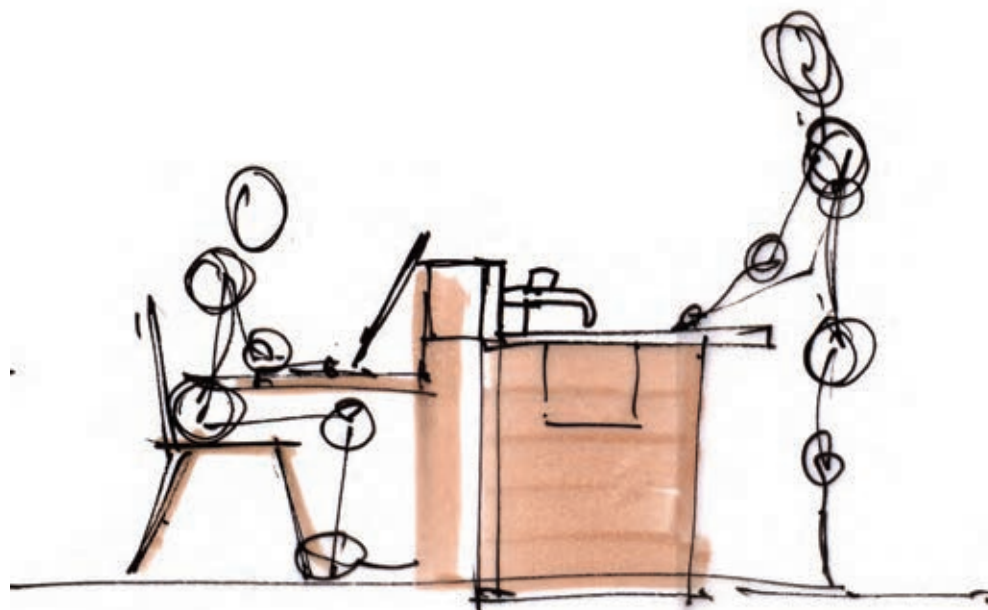

Overview

The needs of the modern science classroom have changed considerably over the past few years. This accelerated change has heightened particularly over the past decade with advances in modern technology. With pupils being taught in dated learning environments this does not reflect the needs of the modern pupil nor does it take into account modern curriculum changes. Indeed these environments can restrict curriculum change as they don't offer the flexibility required to teach contemporary science. One of the driving factors behind the 'Schools for the Future' document is to make schools a more interesting and inspirational place to be. According to this report "a better designed space should

encourage and inspire students". The environment a pupil is taught in can be linked to how that pupil learns. By improving laboratory design this can help to raise educational standards and hopefully increase popularity in the subject of science based subjects. This is borne out in the N.I. Audit Office Report Building for the Future, "Improvements in design and construction, if applied could have a positive impact on educational attainment...". These changes can include everything from seating to ICT to colour. The main issues discussed in this report include:

- ICT
- Laboratory flexibility
- Teaching
- Ergonomics

They are meant to act as a

template for sparking debate to encourage changes within science classroom design. By encouraging new ideas and fresh thinking schools can offer an environment that is stimulating to pupils and encourages productive learning

ICT

The biggest change in learning environments in the past decade has been the advances made in modern technology. Industry requires a workforce that is competent and comfortable in using technology to help them with their work. This has changed the way subjects are taught unlike anything seen since the introduction of the blackboard. Modern school laboratories will have to accommodate these changes as it is very likely that in the near future all children will have their own computer hardware at home and in school. This will allow them access to virtually unlimited learning resources. Indeed this has already begun with the Education Technology strategy in Northern Ireland resulting in managed services and broadband access to all schools primary and post primary and it is vital that these new technologies are taken advantage of and introduced into the learning environment. The proposals put forward in this report incorporate a significant increase in the provision of ICT. The contributing factors to the provision of these facilities include safety, accessibility and space. Science as a practical subject uses electrical, gas and water services so safe separation of practical areas and general learning areas is achieved. With teaching group sizes still at 26 pupils it is vital that the provision of this hardware doesn't impact on learning or teaching space. Advances in technology like LCD monitors require less space and even furniture can be more adapt-

able to allow students access to ICT facilities when required.

Flexibility

The key factors behind science laboratory design are flexibility, adaptability, durability, quality and value for money. Modern curriculum changes require laboratories to be changed quite regularly to adapt to different teaching strategies. One of the key aspects of the proposals put forward in this report is the ability to change a laboratory easily and efficiently to meet teaching and learning needs. The rationale behind the development was that any teacher could change their teaching environment quite easily and quickly without the need for extensive changes to the infrastructure of the classroom. If science is to be taught in a modern way it is vital that laboratories can adjust to meet required changes. Teaching and learning have moved away from didactic teaching mode with the teacher at the front of the room to a more interactive learner centered approach. Indeed the facilities to teach modern science require that laboratories have the capacity to accommodate formal teaching, the use of ICT, practical activities and group work.

Teaching Strategies

The teacher's role within the modern school laboratory has changed significantly with curriculum changes. Teachers are required to make full use of the available space in the laboratory whether didactic teaching, using the interactive whiteboard or demonstrations including the fume cupboard. The main teaching space will need to include a combination of display, storage and easy ICT access. In the following proposals the teacher's desk which often formed a physical barrier between the teacher and pupils has been removed.

This should encourage a more pro-active teaching and learning experience.

Ergonomics

According to the Design Council (www.design-council.org.uk) "Ergonomics is about ensuring a good fit between people the things they do, the objects they use and the environment in which they work, travel and play". In a classroom this can relate to everything from seating, to bench height, to flexibility. Activities have been a driving force behind a lot of the design decisions made in the following pages. Parameters like bench height have been configured in relation to a pupil's activity. In laboratory 3 (p.29) for instance CPU's are used on benching of 750mm in height as is recommended in the building handbook because it means that a monitor is at a recommended viewing height with the users feet placed firmly on the ground. With increased use of ICT in the science laboratory the future trend may be that science stools will be replaced by adjustable seating. Other factors taken into consideration include standing height work surfaces for practical experiments, flexible furniture to allow reconfigurable spaces and adjustable furniture for special needs pupils.

Observations & Objectives



Problem: Existing layout is restricted to particular group sizes mainly working in groups of 4-6.

Proposal: Adapt laboratory to facilitate a wider range of group activities.



Problem: Fixed furniture restricts the movement within the laboratory that allows for other laboratory activities such as role play and demonstrations using the fume cupboard.

Proposal: Flexible use without the need for major restructuring of space.



Problem: Teacher's desk becomes a storage area creating a barrier between the teacher and student.

Proposal: Services / storage for teacher using integrated teaching wall.

Problem: In some configurations pupils can have their back to the teacher and in other cases students to the front can restrict the view of the students seated at the desks at the rear.

Proposal: Improved sightlines for teachers.



Problem: Existing layout only has room for 4-6 computers that are usually located to the rear of the laboratory.

Proposal: Integrate IT at desktop level / Improve ratio of computers to students.



Problem: Floor space is restricted by large storage spaces to the perimeter of the laboratory. Sometimes these storage spaces are too deep to utilise fully.

Proposal: More efficient use of floor space by revising storage / benching.



Problem: Uninspiring furniture and poor colour selection can make existing laboratories look dull and dated.

Proposal: Create a stimulating learning space more akin to an industrial environment.



Problems: Higher stools are required for normal class activity at laboratory benches and stools can be a safety hazard during practical sessions.

Proposal: Provision of split level working surfaces to ensure correct posture and ergonomics and remove stools from the practical area.

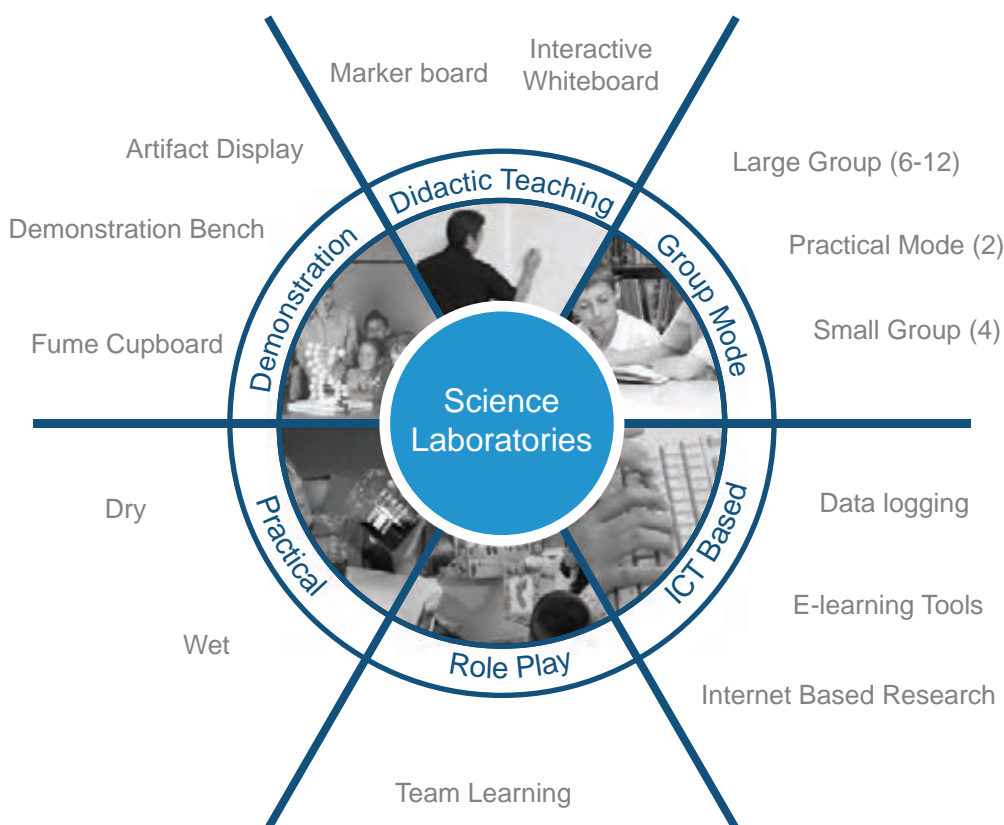

Forms of Teaching



A well designed laboratory should encourage all forms of teaching whether didactic, demonstrations, group activities, ICT based, and role play. Each of the following laboratories strive to make the teaching experience more productive for both teachers and students. A major factor behind their design is that each laboratory should have the capability to accommodate all forms of teaching. By offering easily adaptable rooms this encourages teachers to partake in different exercises therefore keeping the classroom environment both stimulating and exciting. Offering these different forms of learning creates a more industrial and professional environment for students therefore increasing their respect for and interest in the science based subjects.

End user needs



Student



Teacher



Technician



Maintenance

An environment that stimulates students and encourages productive learning.

Facilities that allow for easy integration of ICT facilities and allow students ease of access to on-line learning.

A safe environment that encourages practical experimentation.

A learning space that integrates modern technological advances with practical experimentation.

Maximum space

An ergonomically comfortable environment that encourages good habits in relation to posture etc.

Display areas to encourage an active interest in science.

A flexible reconfigurable space to suit curriculum change and advances in technology.

An ease of use that doesn't interfere with the teaching process.

A teaching environment that encourages other forms of teaching, notably demonstrations, groupwork and practical experimentation.

A practical space that makes a division between wet and dry areas.

Accessible, tidy and clean storage space.

Display areas for student work and objects of interest.

Good sightlines for constant observation of students.

A space that can be easily reconfigured without the need for major changes to the infrastructure of the laboratory.

A space that can be reconfigured in the quickest time possible.

An easily managed space that requires minimal maintenance.

Accessible, tidy and clean storage space.

Good aisle space to allow easy access with service trolleys etc.

An easily managed space that requires minimal maintenance.

Movable furniture that allows all areas to be cleaned.

Movable furniture that can be reconfigured to suit curriculum needs.

Easy access to services for maintenance.

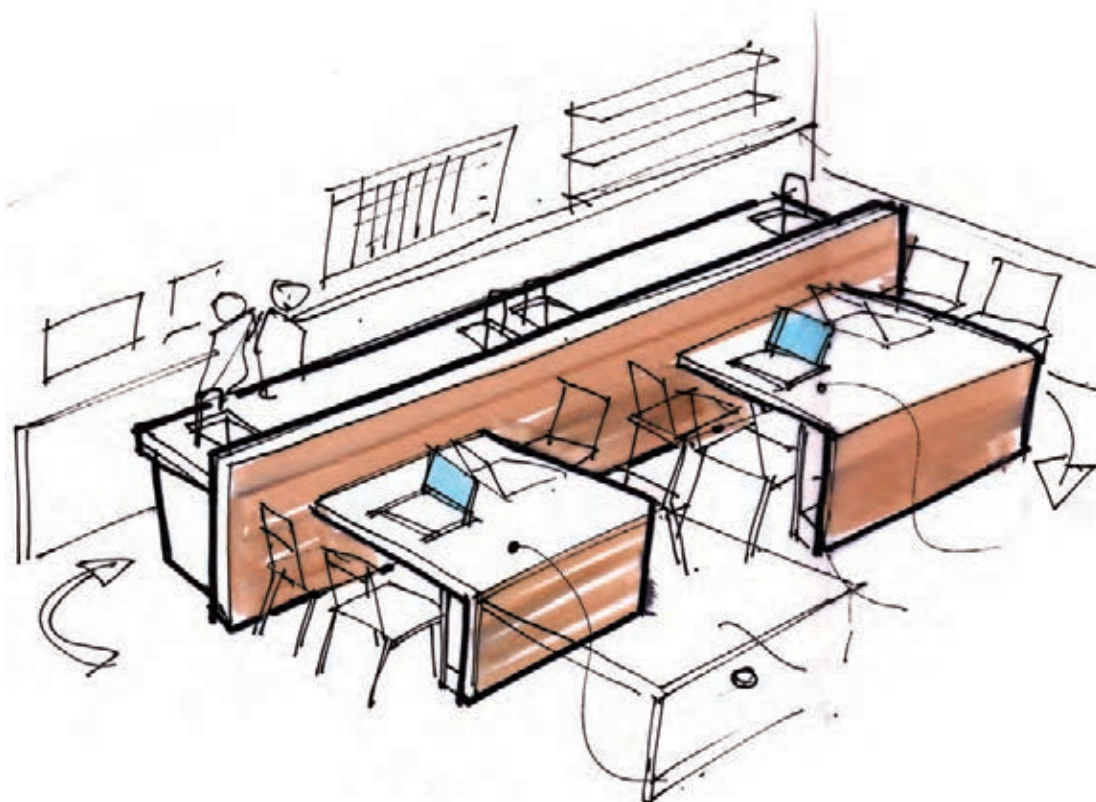

Inspiration

The basis for the ideas in the following pages is to create a learning environment which is beneficial to both teachers and students alike. It has to be an environment which promotes good teaching practice as well as being an effective learning environment for pupils. It should encourage a passion for the subject particularly in relation to experimental and investigative work. Pupils should feel inspired to take an active and purposeful interest in their subject which should heighten their educational experience. The following ideas encourage pupils to engage actively in all aspects of science, from practical work to data logging to groupwork. The main issues explored in

the following concepts include flexibility, adaptability, ease of use, sustainability and practicality. These ideas have a level of flexibility which allows them to be reconfigurable within an everchanging curriculum. Also they are adaptable to meet changes in technology and its implementation within the learning experience. These laboratories have an ease of use which allows them to be reconfigured by teachers or support staff without the need for external help.

A laboratory can even be reconfigured between classes to suit the following class' needs. Safety is also explored in such areas as fume cupboard placement and movement areas.

Many of the ideas are borrowed from other interior spaces like offices, kitchens and bedrooms. The teaching wall for instance, which incorporates a slide robe such as those seen in bedrooms, is a good double use of space as it is multi-purpose, providing storage and display areas. Large whiteboards that are more commonly found in office environments can encourage students to partake in group activities. Offices provide the inspiration as well for the wall rail which allows presentation boards, pinboards and whiteboards to be easily attached to the wall and used as teaching aids. This facility could be adapted to store teaching and learning resources and science equipment.

laboratory 1

Integrated Learning







Laboratory Size : 90m²
Pupils : 24-26
Computers : 12
Sinks : 12
Storage : 13.71 m³
Display : 15.16 m
Worktop : 27.12m²

Laboratory 1

90m² (approx 9m x 10m)

All dimensions in mm

| | |
|---|-------------------------------|
|  | double elect socket outlet |
|  | quadruple elect socket outlet |
|  | single computer outlet |
|  | double gas outlet |
|  | quadruple gas outlet |

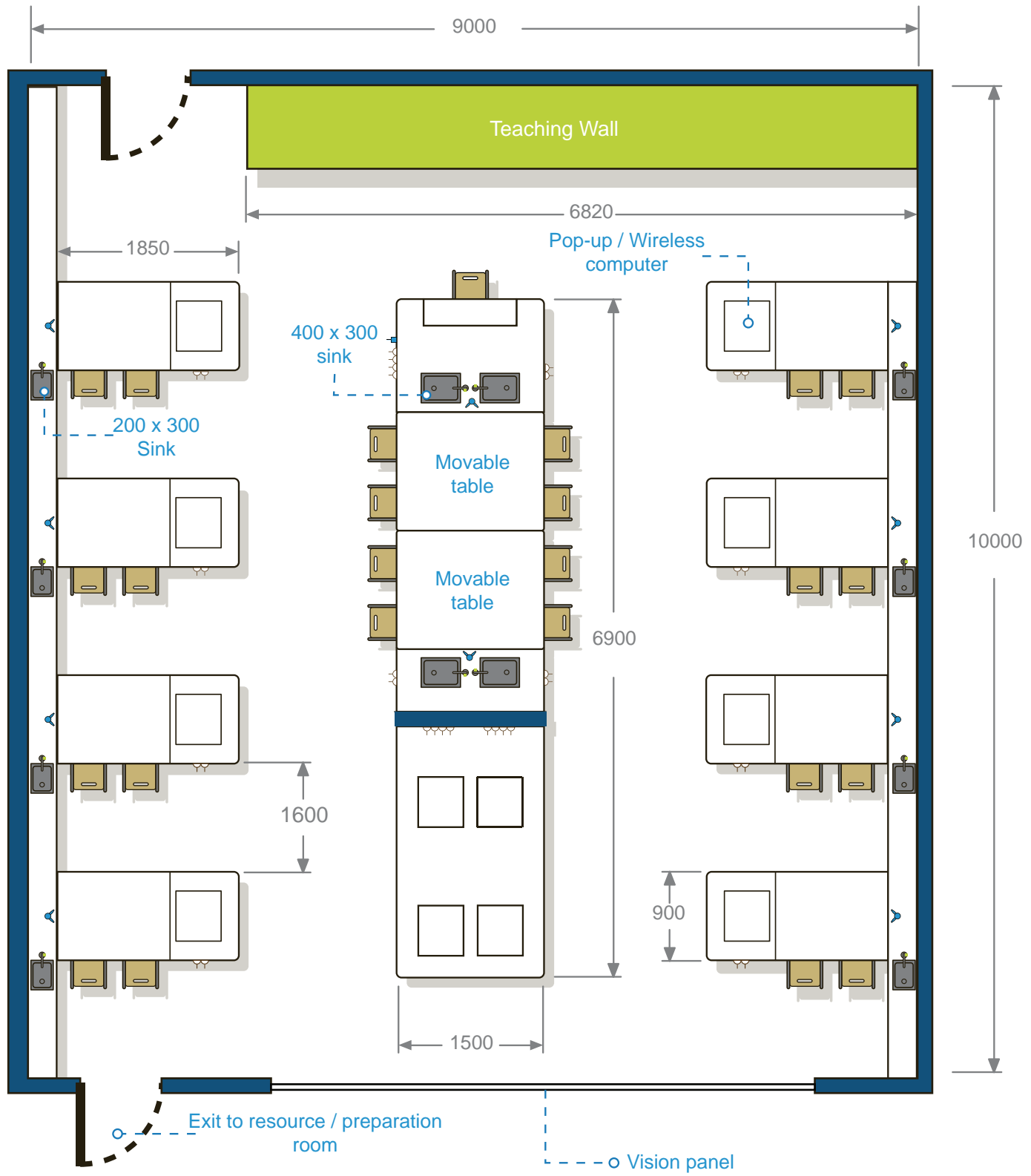

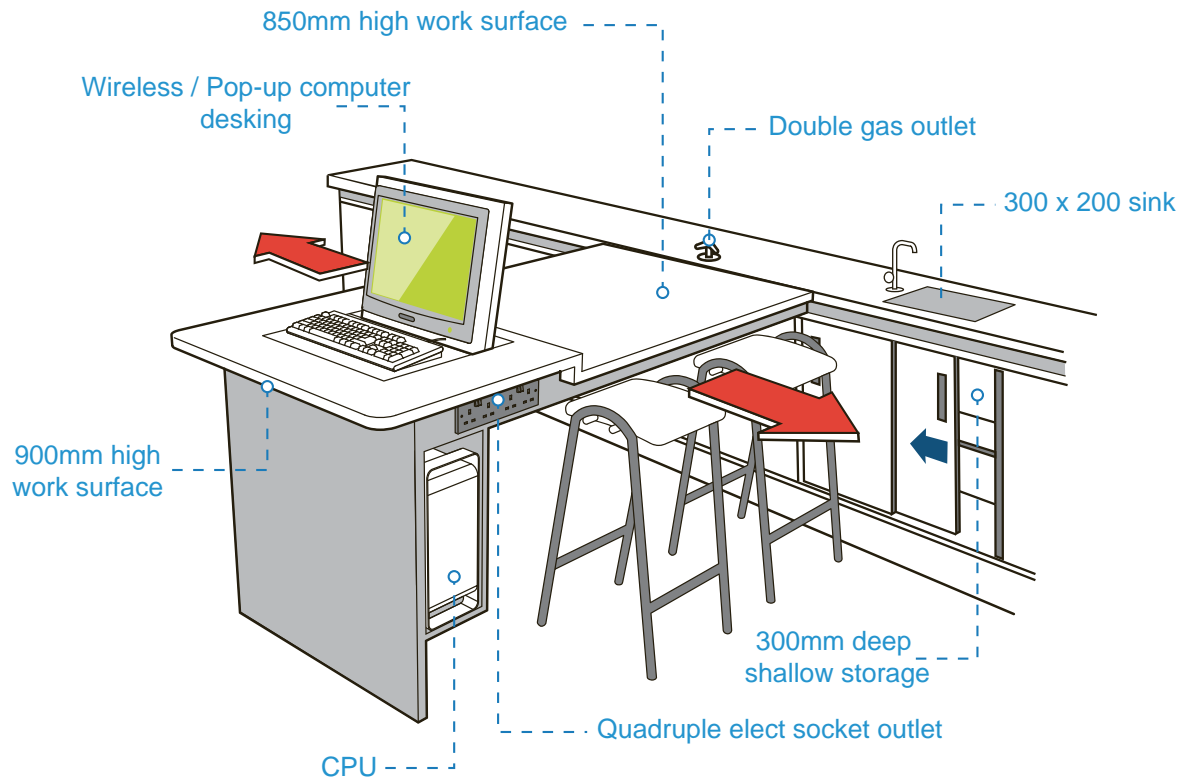

Perimeter Benching

fig. 1

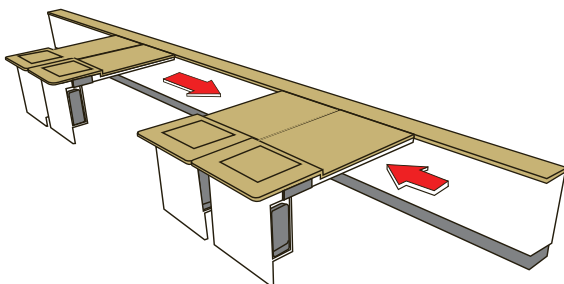
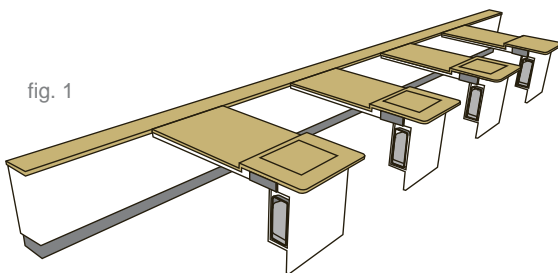

fig. 2

The perimeter benches in this laboratory have the ability to be moved together for groupwork (see fig 2) or moved apart for regular teaching (see fig 1), by means of castors on the benches or rails embedded in the floor and in the fixed perimeter benching. Each bench consists of a practical area at a height of 850mm and a raised area of 900mm for computer use. An integrated wireless / pop-up computer means that this area can be used for data logging or when the computer is removed as a writing area. Each bench is serviced by water and gas on the fixed perimeter benching and by a quadruple electrical socket on the movable benching. There is also some shallow storage available around the fixed perimeter benching. Each bench seats 2 pupils.

Formal Teaching Mode

This class of 24 pupils consists of 16 pupils in groups of 2 situated around the perimeter of the laboratory. The remaining 8 pupils are seated at the upper end of the central island in close proximity to the teacher. This configuration has the advantage that all pupils around the perimeter face the teacher during conventional teaching mode. The perimeter benches are each serviced by a 200mm x 300mm sink and a double gas outlet. The central island is serviced by four 300 x 400 sinks and 2 double gas outlets.



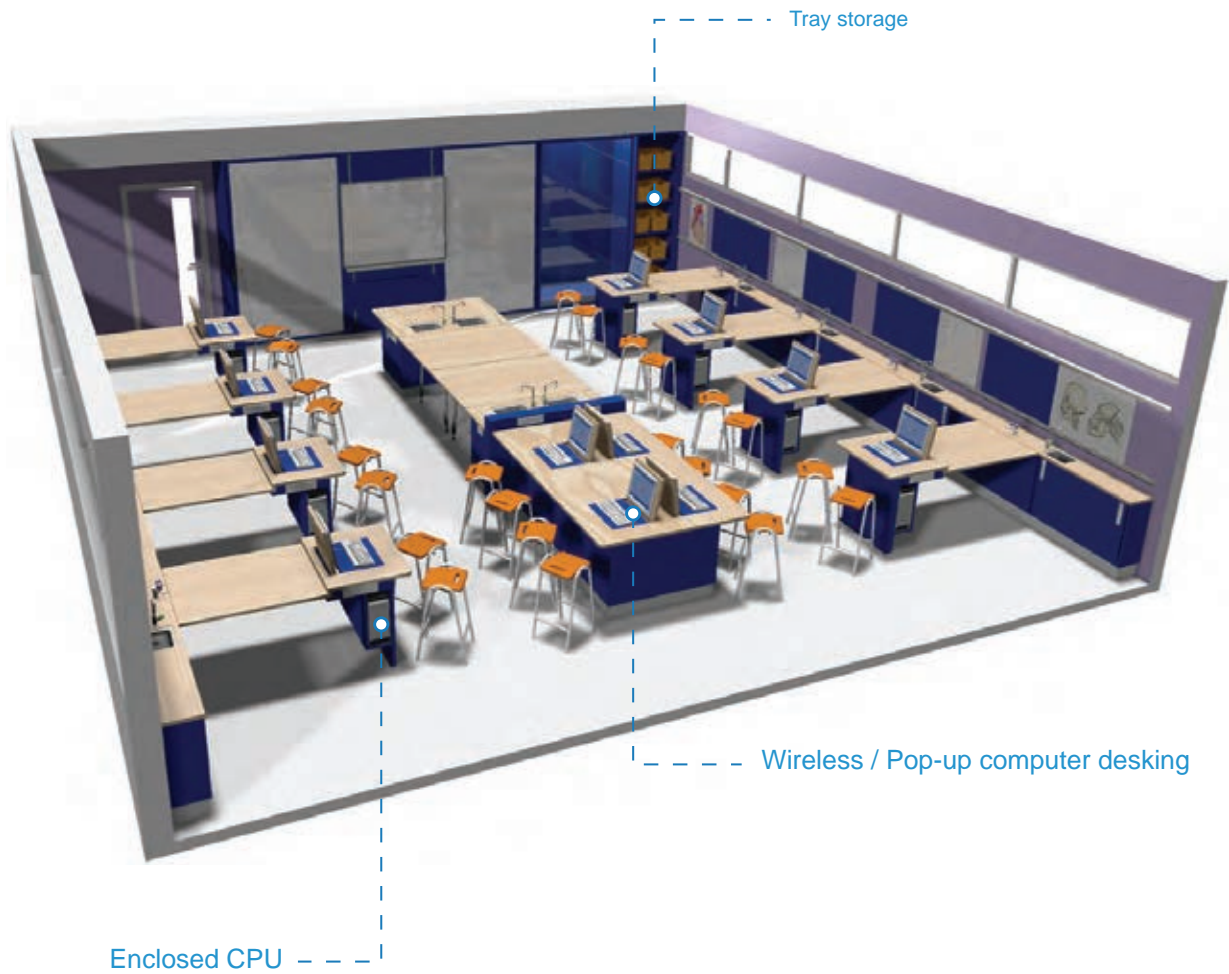

ICT Access

This laboratory is serviced by 12 pop-up / wireless computers giving 1 computer per 2 pupils. Around the perimeter the computers are located on the raised end of the perimeter benches. This surface is raised



to height of 900mm to protect the computers from any accidental spillages during data logging based experiments. On the central island the 8 pupils are served by 4 wireless / pop-up computers located at the bottom end of the benching. This area is again at a height of 900mm and is additionally protected by a dividing wall from the experiment area. One main advantage of this configuration of computers is that the teacher can see a majority of computer screens from any location in the laboratory.



Laboratory 1

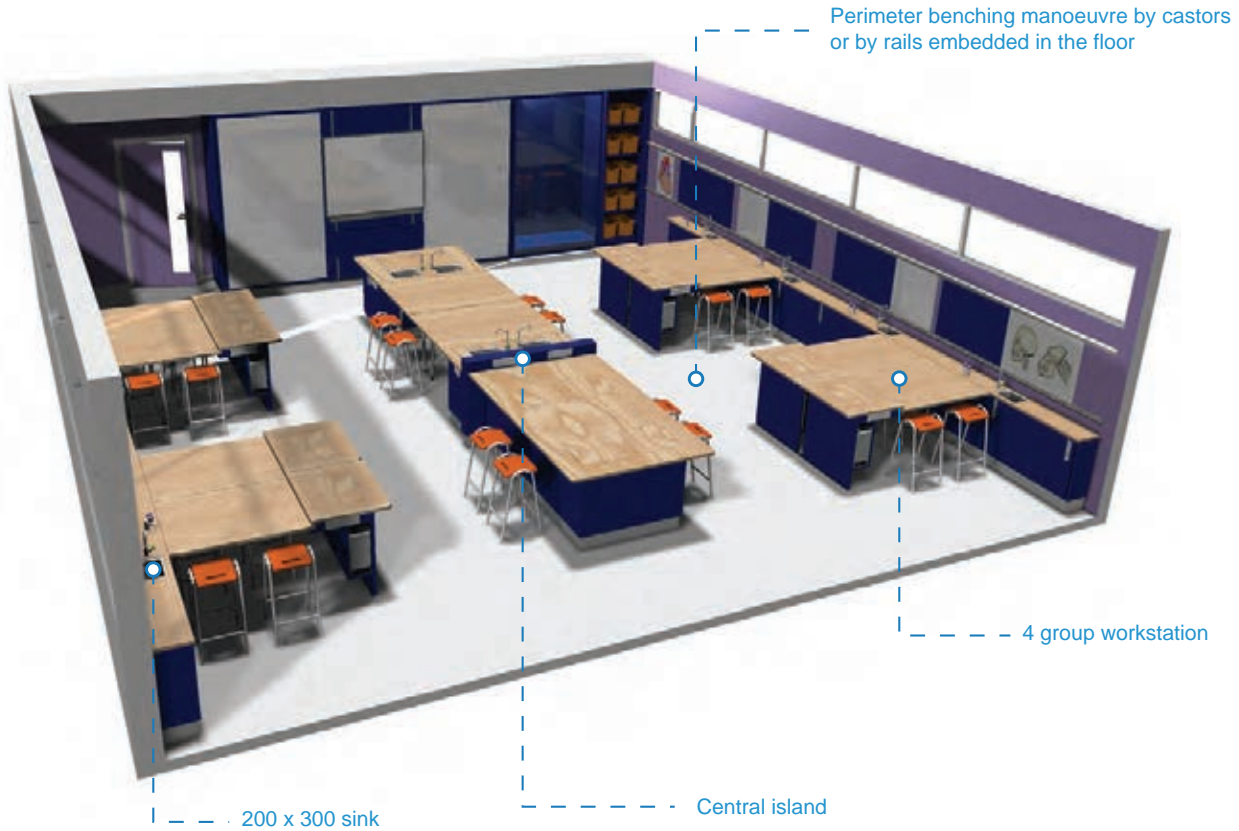

Practical Mode

In practical mode each group is served by the 8 perimeter sinks and by 4 of the double gas outlets. In the centre of the room 4 students are located at the bottom end of the central island giving 2 groups of 4

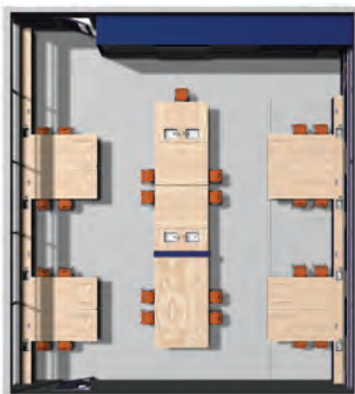

Group Discussion

In group discussion mode the class of 24 breaks into 6 groups of 4. Around the perimeter, benches are pulled together on rails to create 4 groups of 4. Students are seated at opposite ends of these newly created larger tables that are approximately 180cm x 180cm in size.

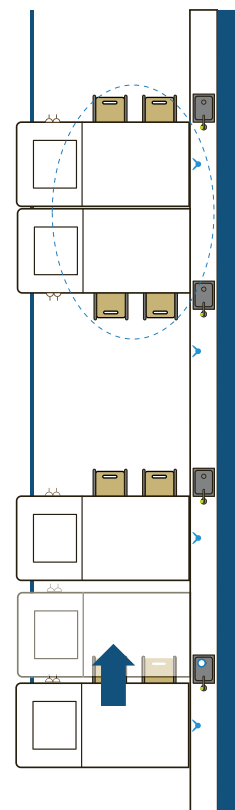



Role Play

On the wall with the display boards the perimeter benches are moved to the ends of the room to create a large gathering area. The teacher can use this area to encourage role play activities etc. It can also be used as a demonstration area by using posters or whiteboards located on the wall rails. Pupils gather around this space and they can also sit at the opposite end of the central island.



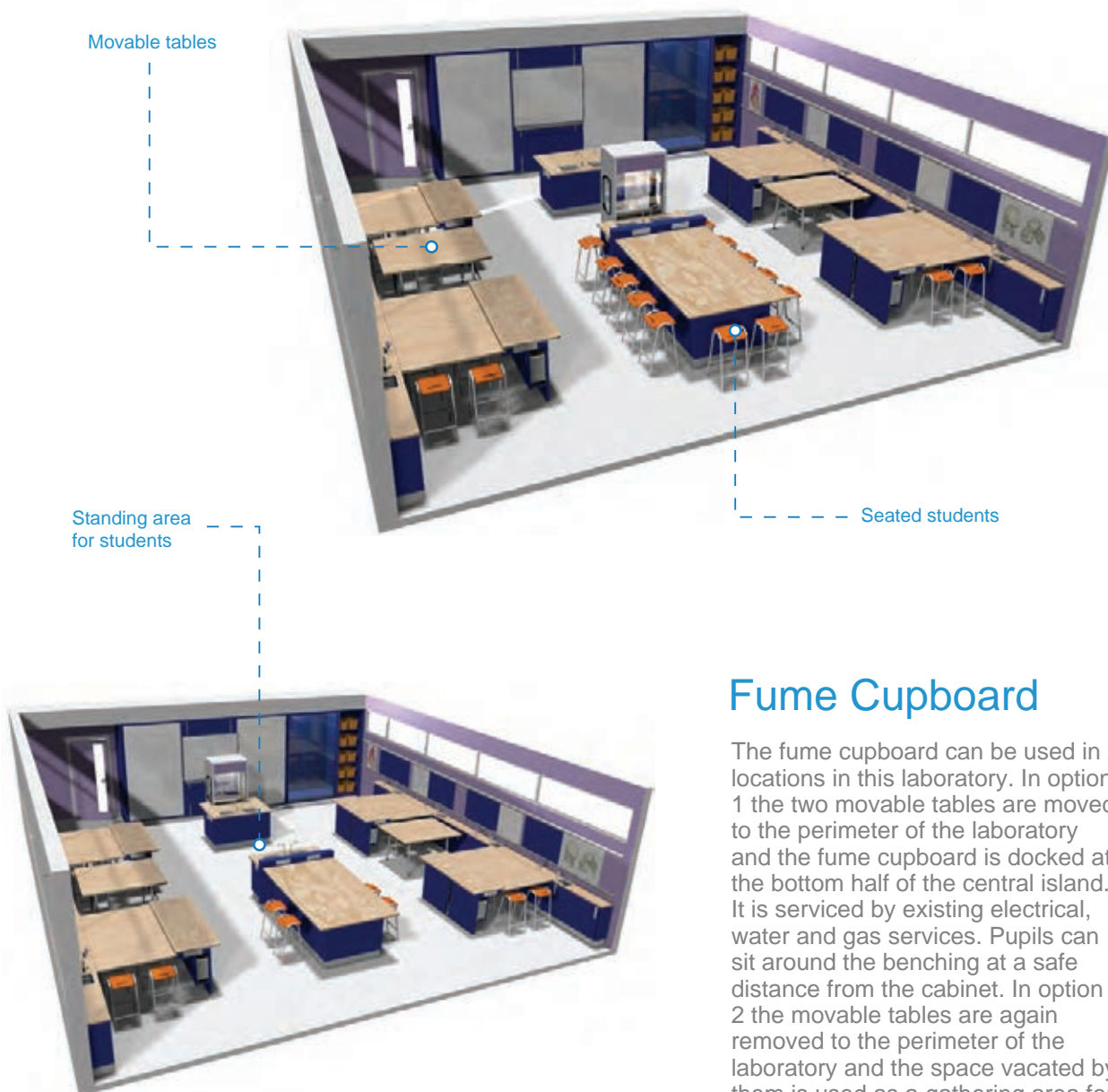

Fume Cupboard

The fume cupboard can be used in 2 locations in this laboratory. In option 1 the two movable tables are moved to the perimeter of the laboratory and the fume cupboard is docked at the bottom half of the central island. It is serviced by existing electrical, water and gas services. Pupils can sit around the benching at a safe distance from the cabinet. In option 2 the movable tables are again removed to the perimeter of the laboratory and the space vacated by them is used as a gathering area for pupils. The fume cupboard is docked at the top of the central island. Students remain to the front of the cabinet for safer experiments.

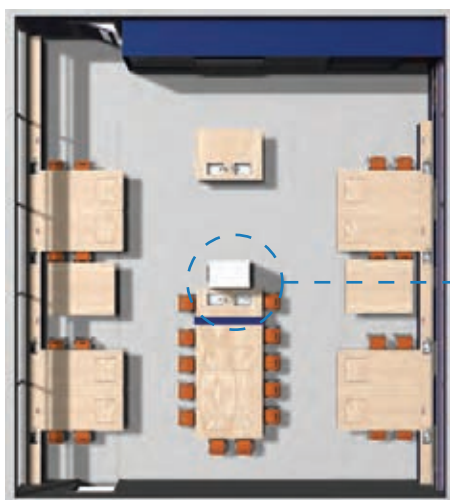

option 1

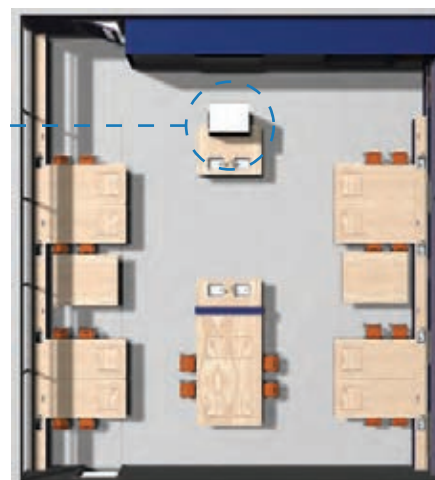

option 2



Electricity and gas outlets

Disabled Access

Students with disabilities can be seated at the top of the laboratory at a specially configured table. This is a change from previous building handbook suggestions which placed special needs students around the perimeter benching of the laboratory (see appendices p.43). This allows the students to have an active role within the class. Electricity and gas is supplied from nearby fixed furniture. The sink is fixed to the height adjustable table with waste exiting via a flexible hose which connects directly to a nearby sink. Connections are made with quick release fittings which allows the tables to be reconfigured for other laboratory activities.

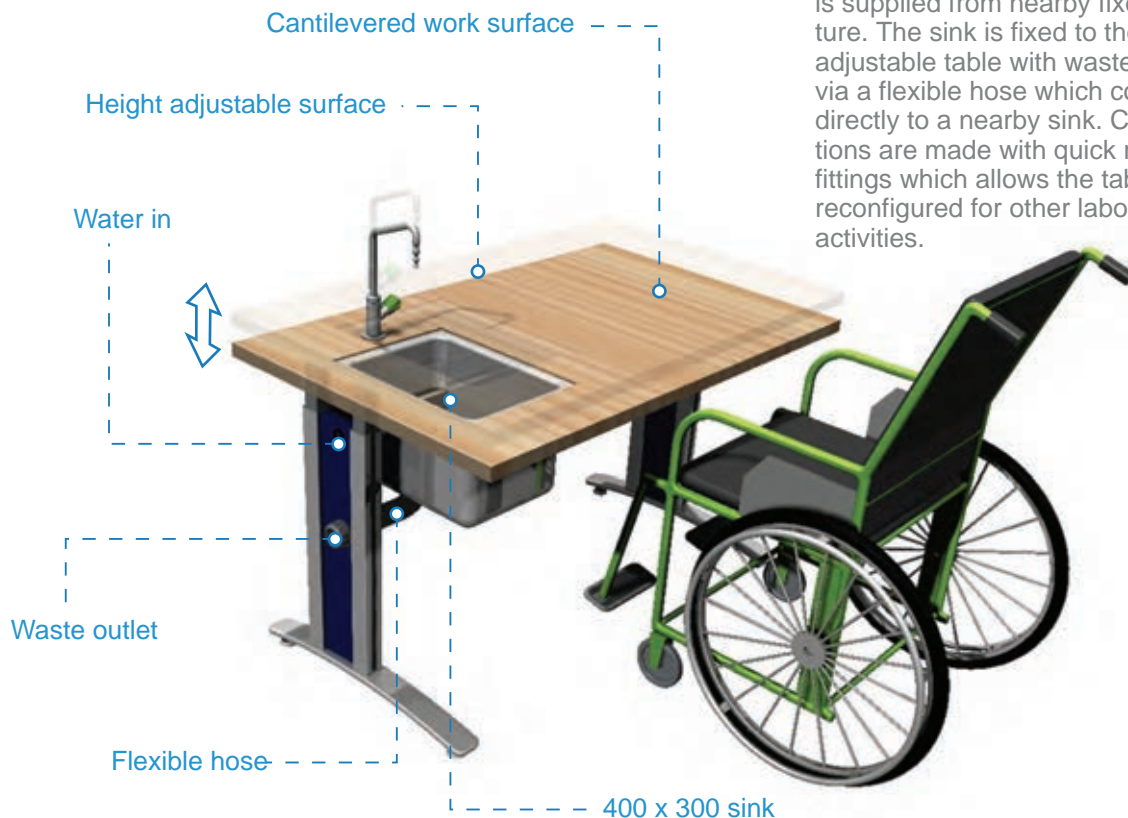

laboratory 2

flexible learning



Laboratory Size : 90m²

Pupils : 24-26

Computers : 12

Sinks : 12

Storage : 12.32m³

Display : 12.28m

Worktop : 21.11m²

Laboratory 2

90m² (approx 9m x 10m)

All dimensions in mm

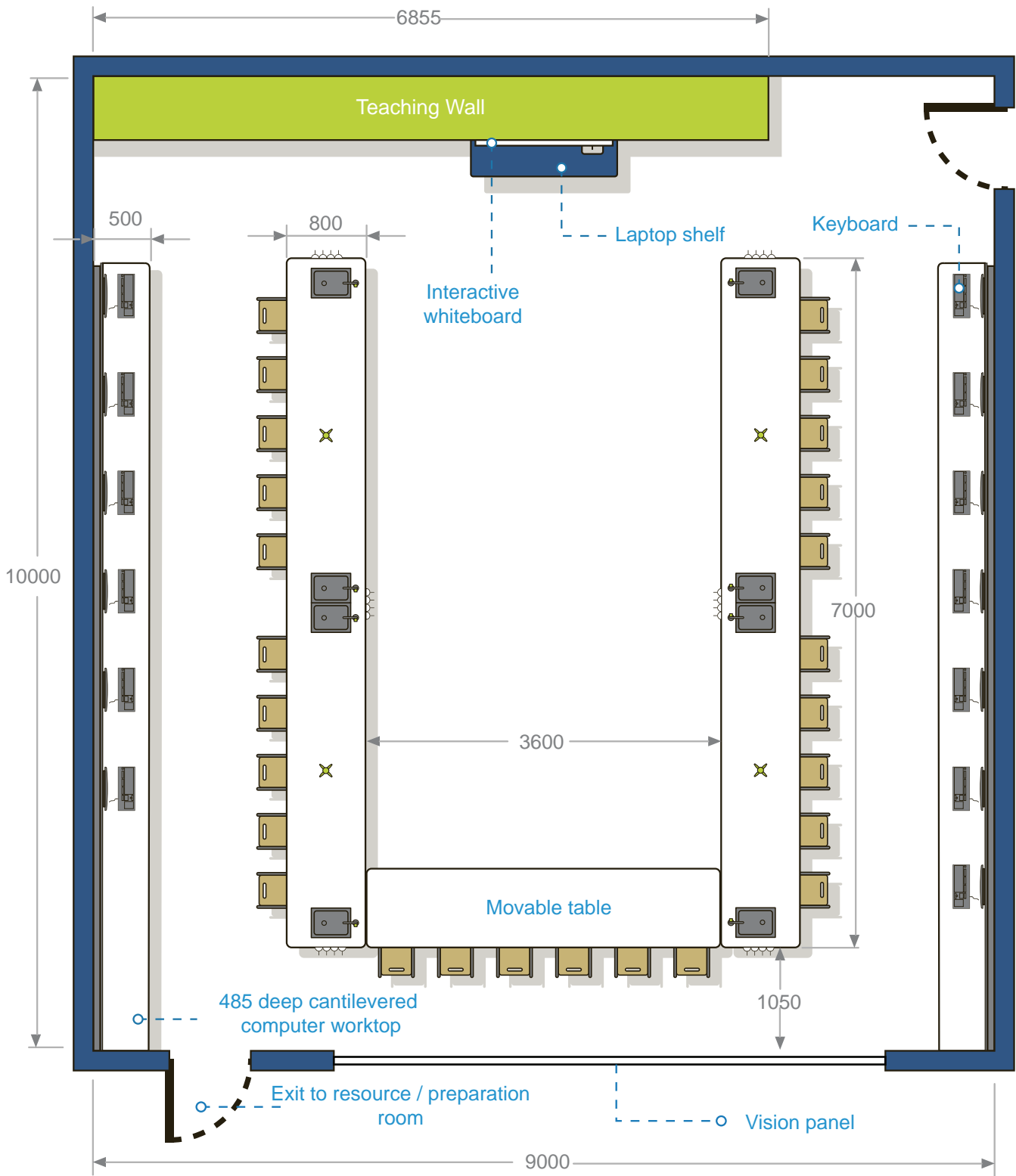
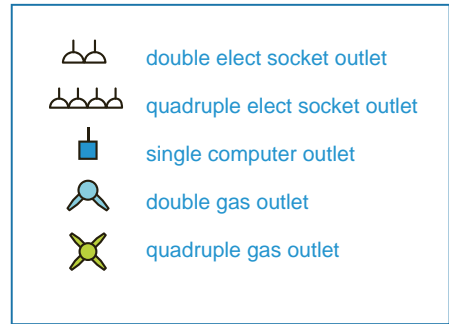

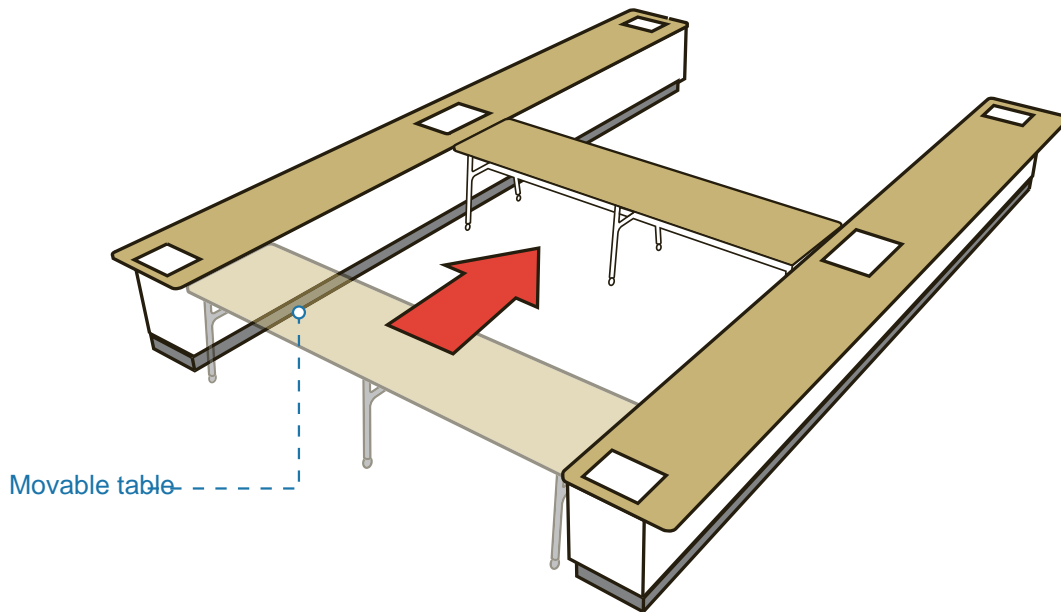

Movable table

Flexibility

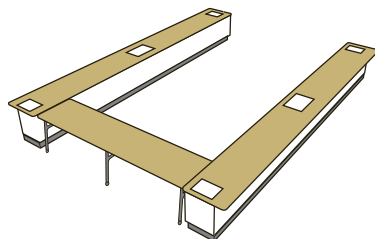

U-channel

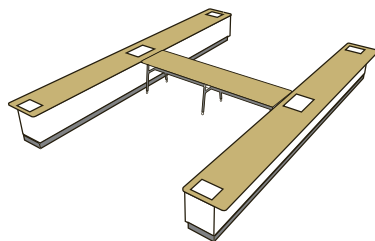

H-channel

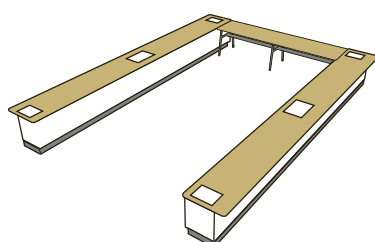

N-channel

This laboratory's main advantage is the flexibility it gives by means of a single movable bench. This means the laboratory can be reconfigured by the teacher without the need for external assistance. The movable table is situated between two long fixed benches and is guided by their edges. Positioning the movable table in different locations gives the opportunities for numerous laboratory configurations. The table can be positioned at the bottom of the laboratory for formal teaching and it can be moved to the centre of the laboratory to give two discreet work areas.



Formal teaching

In formal teaching mode the movable bench is situated towards the back of the laboratory. This table seats six pupils with the remaining pupils seated around the 2 long fixed benches. These benches are serviced by eight 400mm x 300mm sinks and 4 quadruple gas taps. A big advantage of this laboratory is the large open space in the centre of the room in which the teacher can walk around and interact with students and it is also open plan for role play and demonstrations.

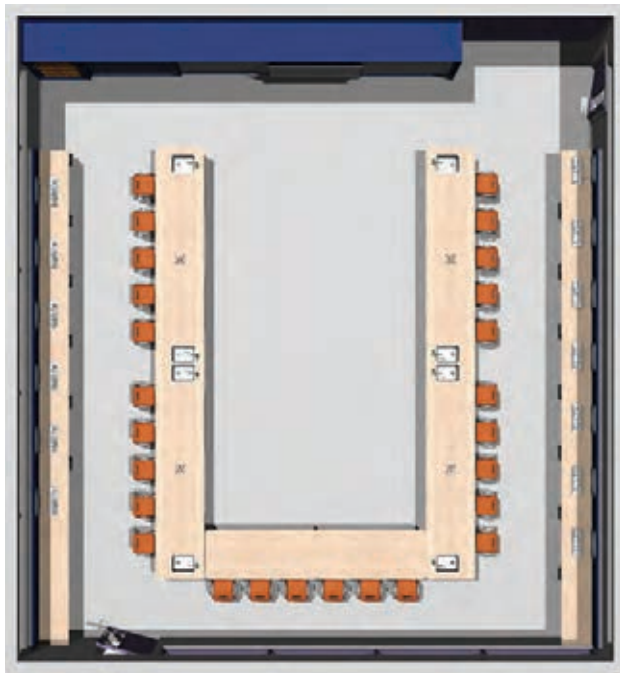

Teaching wall

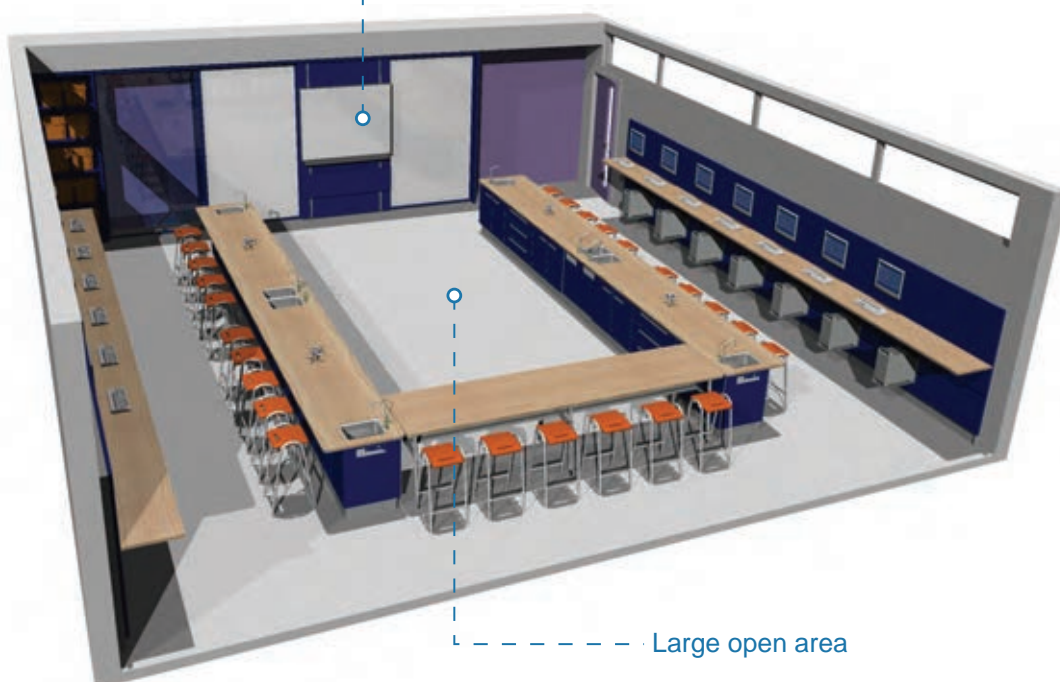

Large open area



ICT Access

Computers in this laboratory are situated around the perimeter of the laboratory in a ratio of 1 computer per 2 pupils. LCD monitors are mounted to wall panelling which hides all the necessary cabling. The shallow keyboard shelf allows for much more floor space within the laboratory. The main advantage of this configuration is that pupils can alternate easily between practical work, data logging and ICT based learning. The configuration can be equally used with laptop computers, removing the need for desktop computers, resulting in additional window / display space.

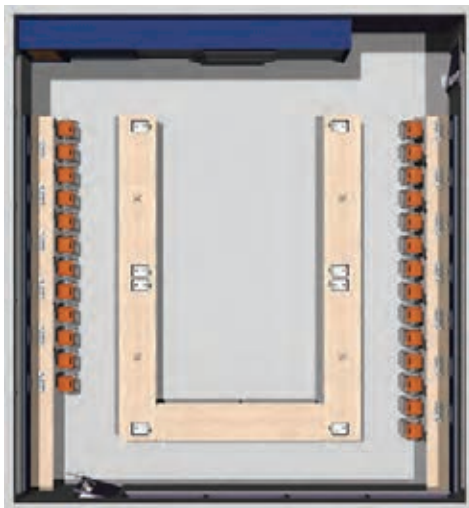

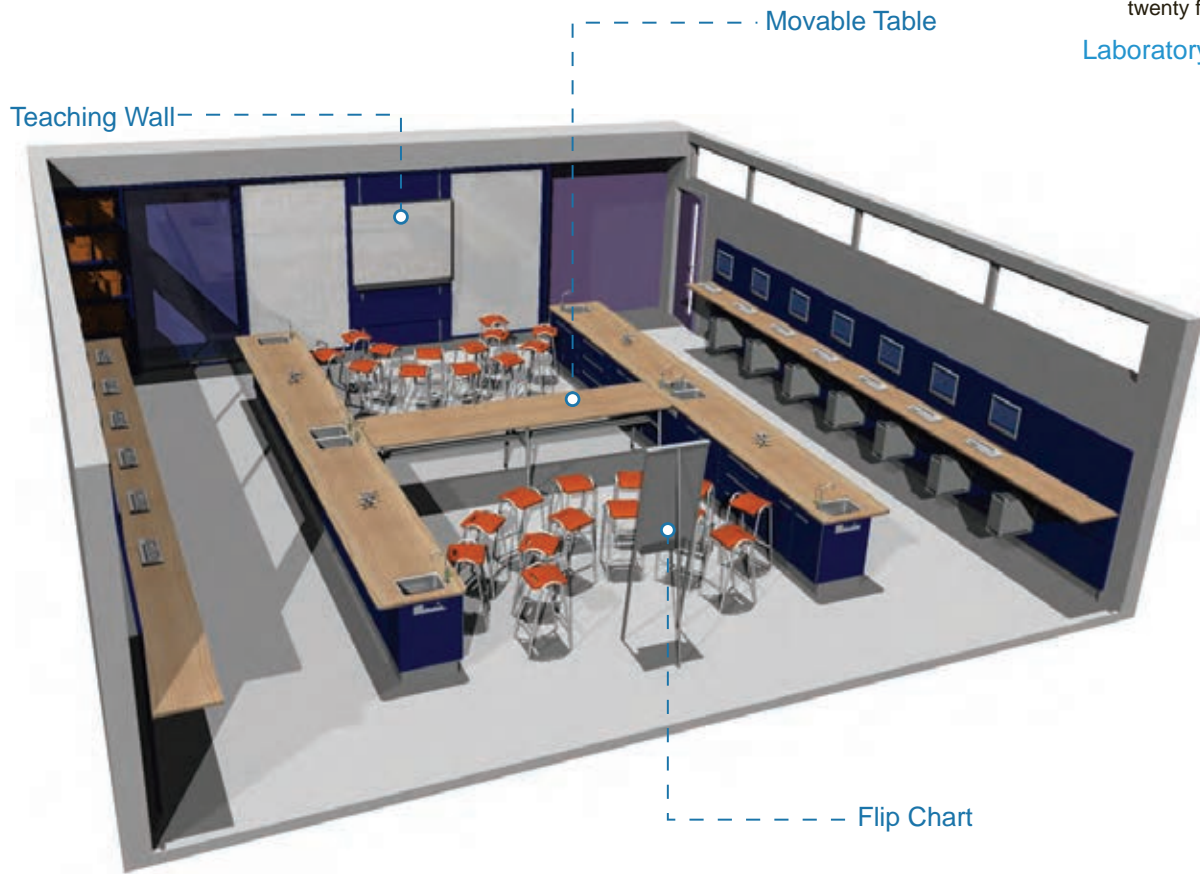

Group Discussion : Option 1

Moving the movable bench to the centre of the laboratory breaks the room into two groups of 13. The top group can use the existing teaching wall and its large whiteboards for group activities. The bottom half can use either whiteboards located on the back wall of the laboratory or a simple flipchart strategically located.

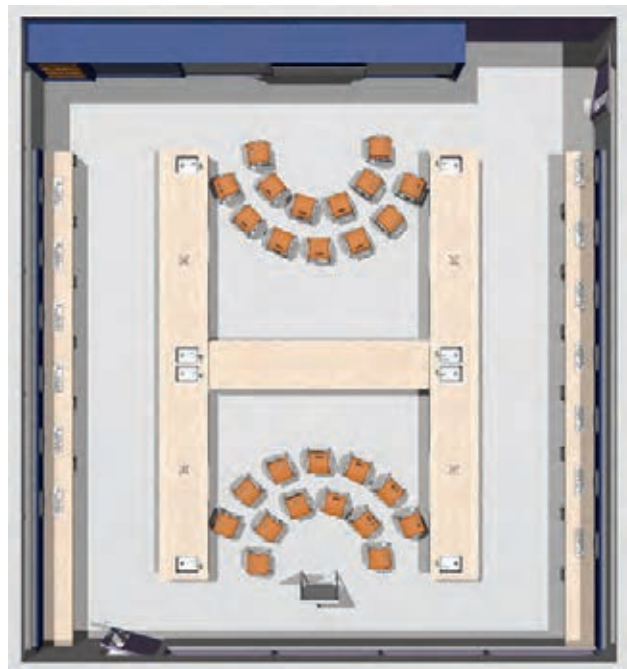

Group Discussion : Option 2

In this group discussion mode the movable table remains in the centre of the laboratory. Pupils are seated at the end of the peninsulas in 2 groups of 7 and 2 groups of 6. Students can also use the movable table as a group base.

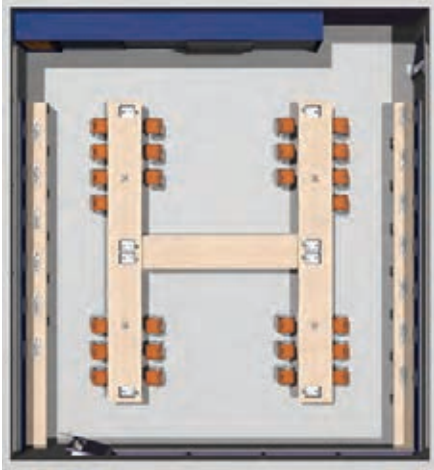

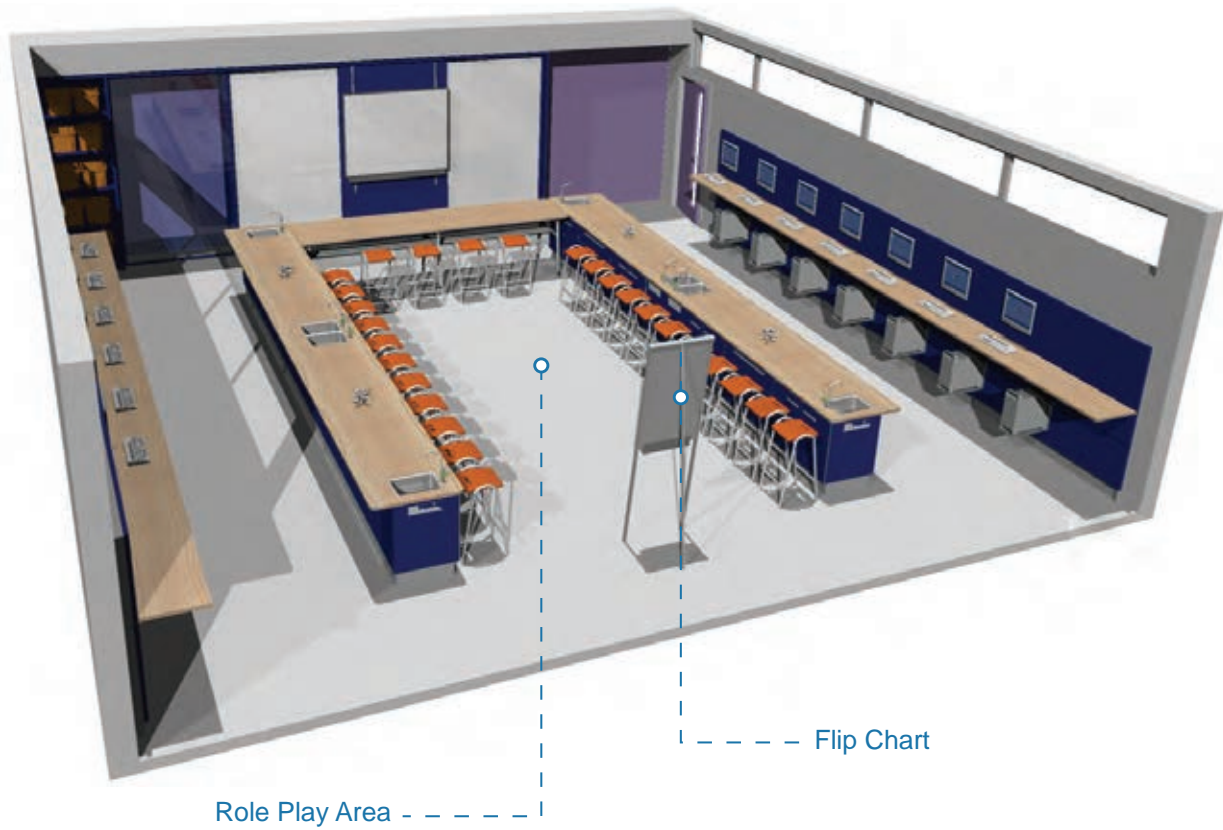

Role Play Mode

In this mode the movable table is moved to the top of the laboratory, effectively switching the direction of the laboratory. This large open space can be used for all types of activities including role play. Students can gather around the central space to create a more intimate group space. A flipchart can also be used for other teaching activities.

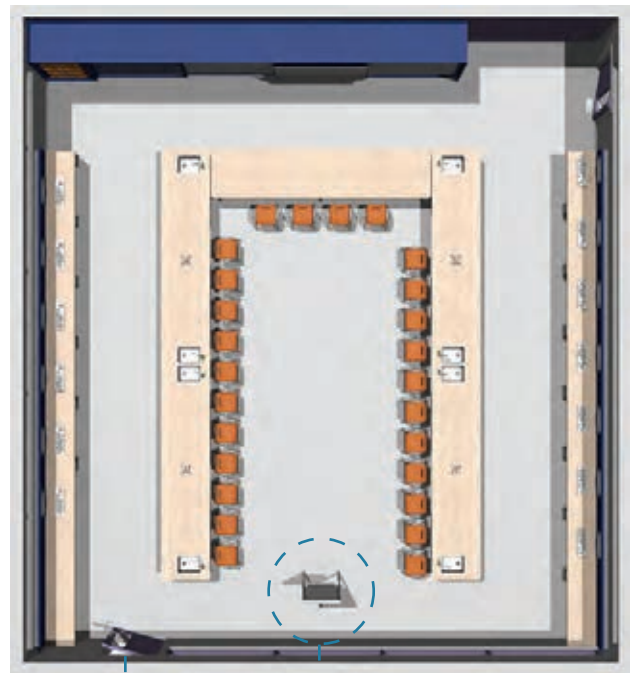

Exit to resource / preparation room

Location of flipchart

laboratory 3

central flexible learning







Laboratory Size : 90 m²
Pupils : 24
Computers : 12
Sinks : 10
Storage : 9.32 m³
Display : 16.16 m
Worktop : 21.44m²

Laboratory 3

90m² (approx 11m x 8m)

All dimensions in mm

| | |
|--|-------------------------------|
|  | double elect socket outlet |
|  | quadruple elect socket outlet |
|  | single computer outlet |
|  | double gas outlet |
|  | quadruple gas outlet |

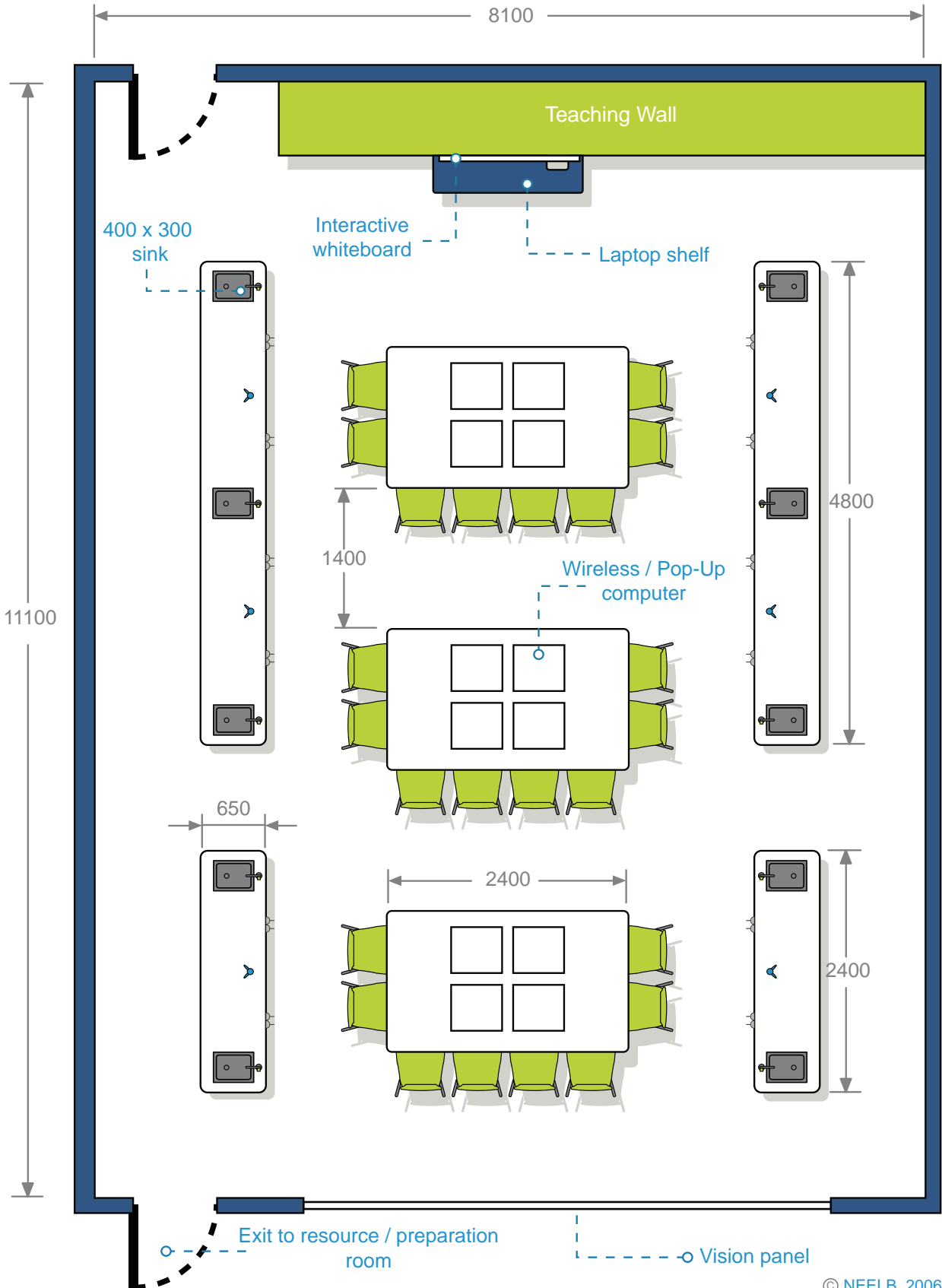

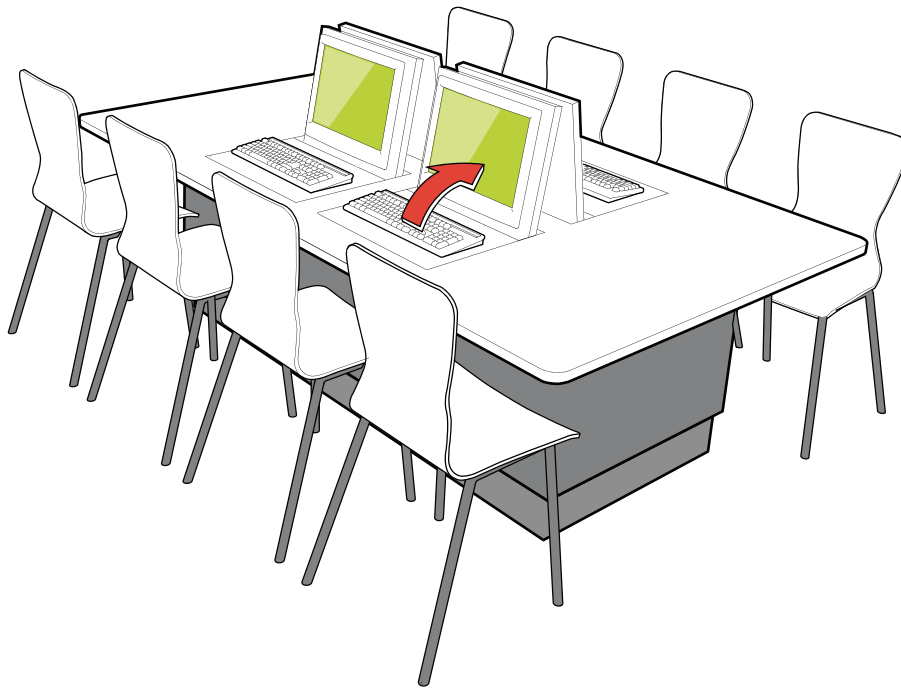

Ergonomics

When using a computer screen it is recommended that both feet are placed firmly on the ground with the monitor at eye level. In laboratory 3 the stools are replaced by regular seating. The central island desking where, written work and ICT use is based, is at the recommended work height of 750mm. The practical area to the perimeter of the laboratory is still 850mm in height since students must stand when doing experiments.



Wet & Dry Areas

This laboratory is divided into two main areas. The dry area is to the centre of the laboratory. It is where students take notes, work on computers and carry out written work, ICT tasks and normal classroom activities (These may include some non-hazardous practical activities e.g. simple circuits). The wet area is on two sides of the laboratory. This is a standing area and it is where most practicals are based. A student can be in close proximity to computer and water without any risk of spillages. For instance, one student can be taking readings from an experiment and the other can be recording them onto the computer.

Wet Area | Dry Area | Wet Area

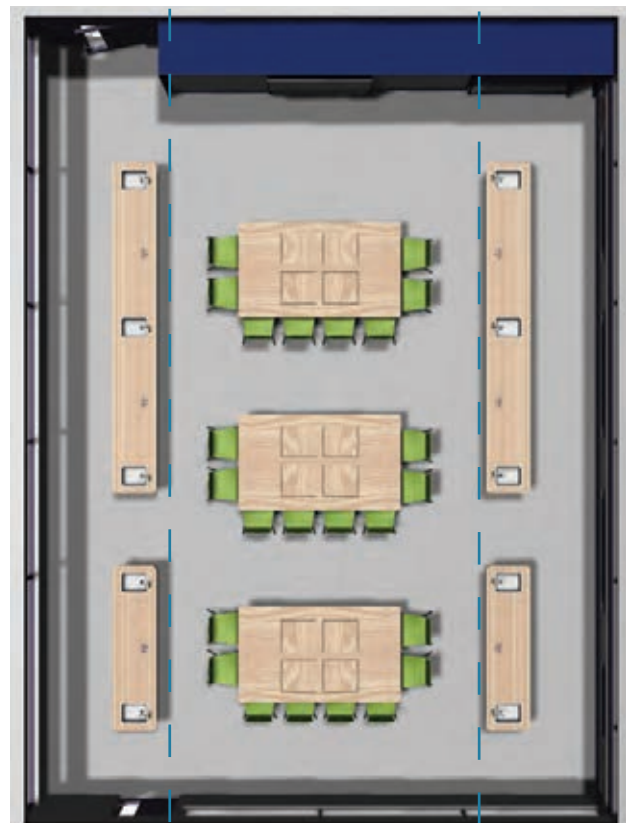

Formal Teaching

In formal teaching mode the class sits in three groups of eight around three large fixed benches which are 750mm in height. Four pupils sit at the back of these benches and four to the side. This area is called the dry area and it is a space where students do written coursework, data logging and possibly experiments that don't require liquids. In this mode of teaching all students face the teacher and the teaching wall.

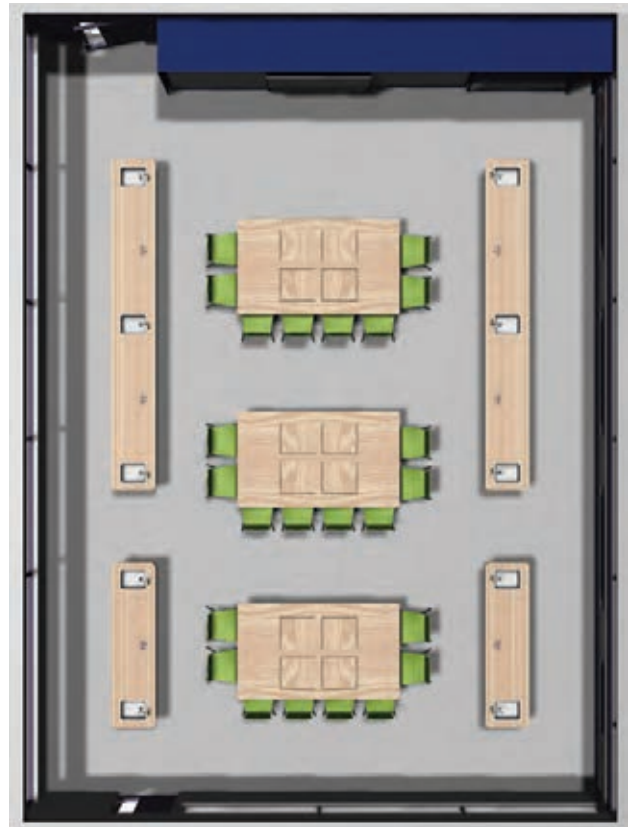



ICT Access

This laboratory has 12 computers for 24 pupils. These computers are located in the central island workstations. These are wireless / pop-up computers which allow the tables to alternate between a writing surface and a data logging area. The computers are kept in the centre of the room in the dry area with the practical work kept to the wet area.



Laboratories Overview

The increased storage capacity of these laboratories is due to the storage contained within the teaching wall. This not only adds vital storage space but it also encourages a cleaner and tidier laboratory environment. The large whiteboards and illuminated display cabinet also increase the display areas offered in laboratories 1 and 2. Laboratory 1 offers the greatest increase in worktop area. The use of wireless / pop-up

computers means that this space can be utilised for other purposes. The design success of these laboratories is the increased access to ICT. Where existing laboratories had, on average, 4 computers these concepts offer 1 computer per 2 pupils. Laboratory 1 offers seats for 24 pupils but it could quite easily seat 26.



| | Existing Laboratory | Laboratory 1 | Laboratory 2 | Laboratory 3 |
|-----------|---------------------|---------------------|---------------------|---------------------|
| Size | 90m ² | 90m ² | 90m ² | 90m ² |
| Seats | 26 | 24-26 | 24-26 | 24 |
| Storage | 6.66m ³ | 13.71m ³ | 12.32m ³ | 9.32m ³ |
| Display | 12.8m | 15.16m | 12.28m | 16.16m |
| Worktop | 24m ² | 27.12m ² | 21.11m ² | 21.44m ² |
| Computers | 4 | 12 | 13 | 12 |
| Sinks | 12 | 12 | 8 | 10 |

Key Features

Concepts and Ideas



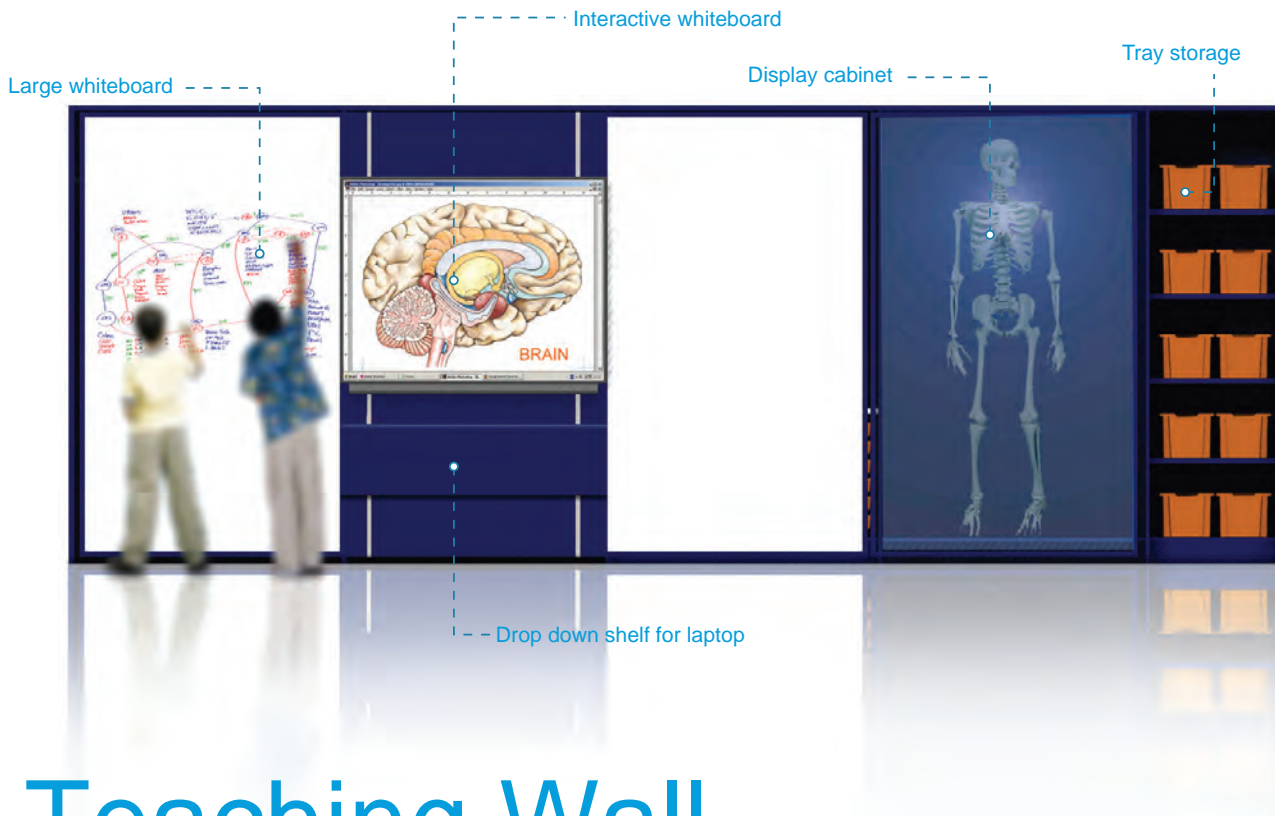

Teaching Wall



The teaching wall is a floor to ceiling multi-functional teaching base. The teaching wall consists of 2 large whiteboards, an interactive whiteboard, an illuminated display cabinet and storage space for books, trays etc. The two large whiteboards can be used by the teacher or by students during group activities. They slide away to

reveal large areas of storage. Between these is the panel on which the interactive whiteboard is mounted. It is a fixed panel with a drop down shelf on which a laptop can be placed during presentations.



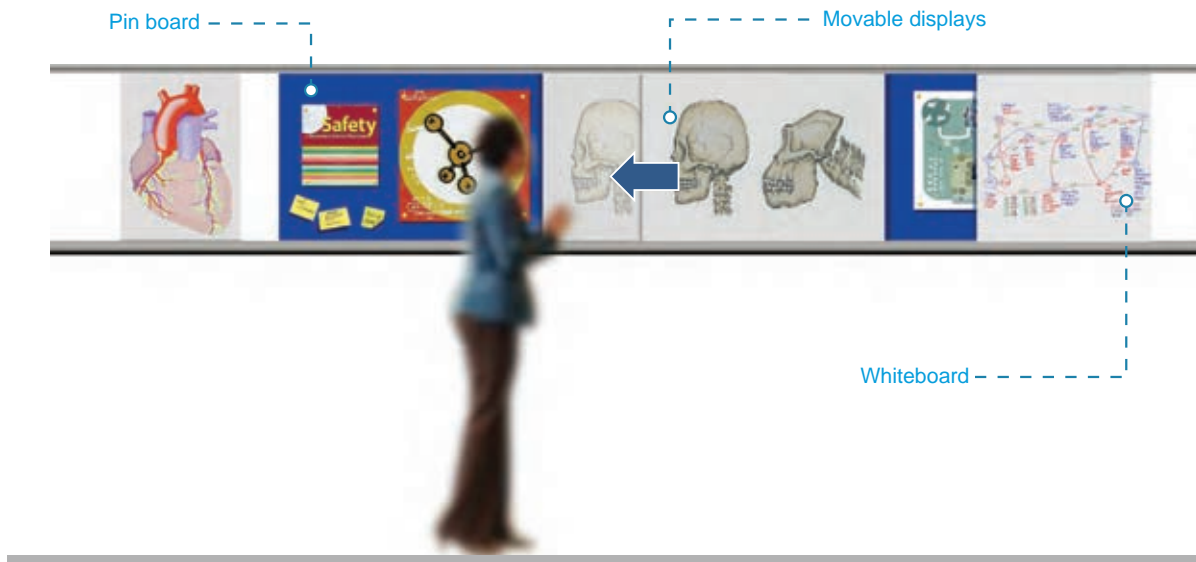

Display Boards

Display boards are mounted on a wall rail system which allows displays to be moved backwards and forwards within tracks. Fixed pin boards can be mounted at the back with other displays sliding over them at the front. Displays can be moved to a particular location on the wall, possibly for student group activity, without having to take posters down from the wall. This wall can be used as an additional teaching space for activities such as role play etc. Different types of display board can include pin boards, whiteboards, poster boards, charts and diagrams, and magnetic boards.



Colour



According to the article 'Colour Schemes seen as the way to better behaviour' (Times, April 30, 2005) "classrooms.....are changing colour as schools discover that children are better able to concentrate in a colourful environment". It goes on to state that "warm, vibrant colours encourage extrovert behaviour and cooler greens and blues promote calmness". Colour can be used to effect positively the behaviour of pupils. It is well known that

pupils respond better to environments that are bright, stimulating and well kept. In these colour schemes contrasting colours are used to emphasise different surfaces. The work surfaces are all light colours to reflect daylight with walls in muted tones. Furnishings are a mixture of secondary colours like green, purple and oranges in conjunction with blue.

calm



muted



vibrant



active



'children are better able to concentrate in a colourful environment'

Times, April 30, 2005

Appendices

References

<http://www.design-council.org.uk/>

Building for the Future - A review of the PFI Education Pathfinder Projects

<http://www.niauditoffice.gov.uk>

'Schools for the Future Building Bulletin 95'

<http://www.bsf.gov.uk/documents/>

Schools for the future Exemplar Designs

<http://www.bsf.gov.uk/bsf/exemplars.htm>

DENI Building Handbook

http://www.deni.gov.uk/schools/school_building/handbook_contents.htm

www.timesonline.co.uk/

For further information please contact...

Sean Maguire

Adviser Science & Technology
North Eastern Education &
Library Board,
Antrim Board Centre
17 Lough Road,
Antrim,
BT41 4DH,
N.Ireland.

sean.maguire@neelb.org.uk

Dominic Logan

Lecturer in Product Design,
Room 80F06B,
School of Art and Design,
University of Ulster,
Belfast campus,
Belfast,
BT15 1ED,
N. Ireland.

dj.logan@ulster.ac.uk

Gareth Ladley

Associate Lecturer - 3D Design,
Room 80E07,
School of Art and Design,
University of Ulster,
Belfast campus,
Belfast,
BT15 1ED,
N. Ireland.

g.ladley@ulster.ac.uk

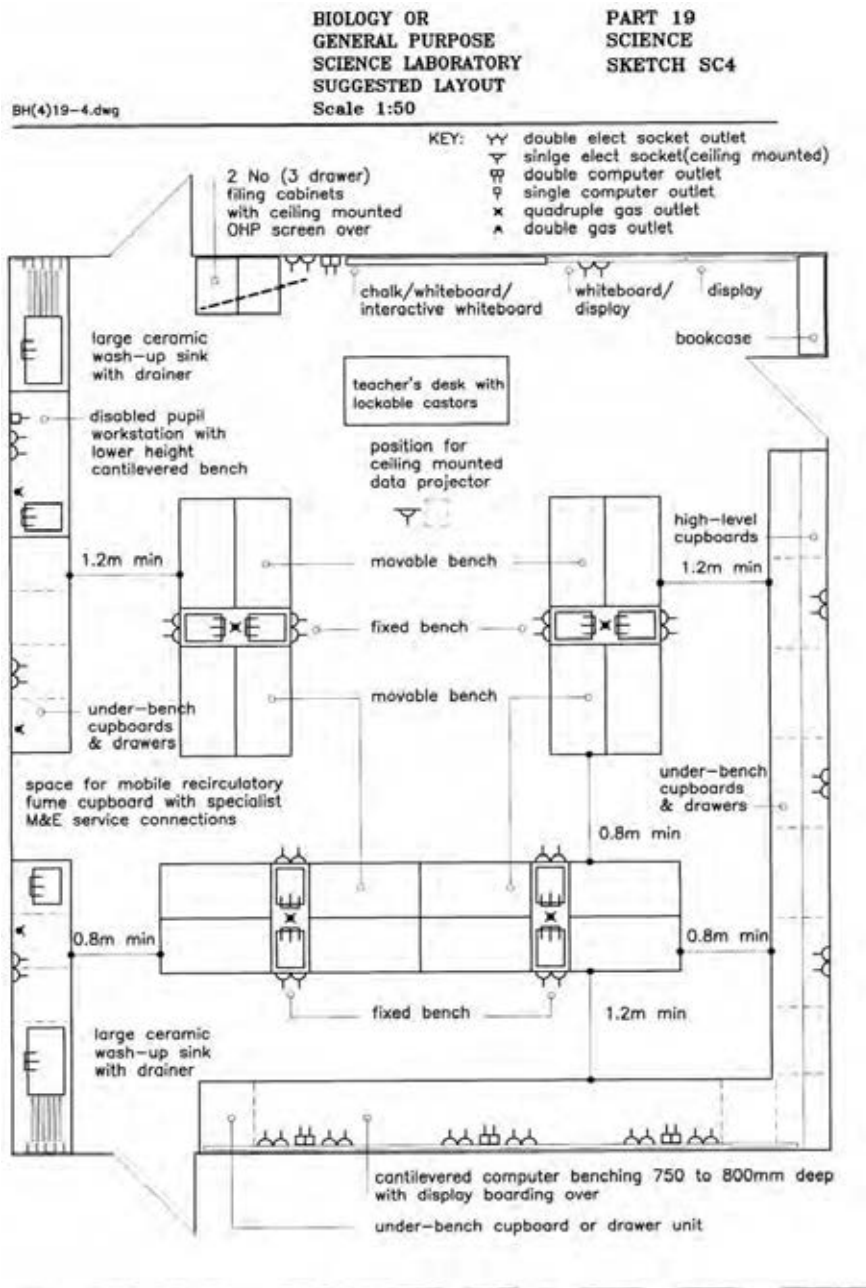

Current general purpose laboratory plan
 D.E. Building Handbook (Part 19, Science)